

# Numerical control

*Compact4*

---

Documentation

## Document description

<b>Date</b>	16/02/2018
<b>Revision</b>	2
<b>File name</b>	eCompact4.pdf
<b>Protocol</b>	
<b>Type</b>	Documentation
<b>Author</b>	T.P.A.
<b>Group name</b>	
<b>Notes</b>	

This documentation is property of TPA. S.r.l.

Any unauthorized duplication is forbidden.

The Company reserves the right to modify the content of the document at any time.

# INDEX

<b>CONTENTS</b> .....	<b>6</b>
<b>1 DESCRIPTION</b> .....	<b>7</b>
<b>2 FUNCTIONAL SPECIFICATIONS</b> .....	<b>8</b>
2.1 General features .....	8
2.2 Specifications of the control .....	8
2.3 Supported field buses .....	9
2.4 Additional functions.....	9
2.5 Power supply specifications.....	9
<b>3 TECHNICAL SPECIFICATIONS</b> .....	<b>10</b>
3.1 Device .....	10
3.2 Interface .....	10
<b>4 ELECTRICAL FEATURES</b> .....	<b>11</b>
4.1 Generics .....	11
4.1.1 Maximum allowed values.....	11
4.1.2 Operating parameters.....	11
4.2 PNP I/O.....	12
4.2.1 Maximum allowed values.....	12
4.2.2 Operating parameters.....	12
4.3 Frequency/direction axes .....	13
4.3.1 Maximum allowed values.....	13
4.3.2 Operating parameters.....	13
4.4 I/f flyer .....	14
4.4.1 Maximum allowed values.....	14
4.4.2 Operating parameters.....	14
<b>5 SIZE AND FIXING</b> .....	<b>15</b>
<b>6 INTERFACES DESCRIPTIONS</b> .....	<b>16</b>
6.1 Power supply connector .....	16
6.2 PS/2 connector for Keyboard and Mouse .....	16
6.3 RS232 and RS485 connectors.....	17
6.4 VGA video out connector .....	18
6.5 LAN and EtherCAT connectors.....	19
6.6 USB connectors .....	19
6.7 I/f flyer connector .....	20
6.8 Frequency/direction axes connectors .....	20
6.9 I/O terminal blocks .....	20
6.10 I/O power supply terminal blocks.....	20
6.11 GBus4 connector.....	20
6.12 CAN connector .....	22
6.13 FRO connector.....	23
6.14 Bright signals .....	24

- 6.14.1 LED ON.....24
- 6.14.2 Red LED (ERR).....25
- 6.14.3 Green LED (STA) .....25
- 6.14.4 ST LED.....25
- 6.14.5 GreenBus LED .....26
- 6.14.6 I/O yellow LED .....26
- 6.14.7 VG yellow LED.....26
- 6.14.8 FX yellow LED .....26
  
- 7 PRESCRIPTIONS.....27**
- 7.1 Operating temperature .....27
- 7.2 Power supply.....27
  
- 8 FIELD CONNECTIONS .....28**
- 8.1 Axes connectors .....28
- 8.2 Flyer connector .....32
- 8.2.1 Flyer wiring example.....32
- 8.3 I/O terminal blocks .....34
- 8.4 Supervisor PC .....35

## REVISIONS

Revision number	Date	Protocol	List of modifications and/or modified paragraphs
Rev 0	28/11/2017		Preliminary release
Rev 1	17/01/2018		First official release
Rev 2	16/02/2018		Update Greenbus Technical Specifications

# CONTENTS

This document describes the Compact4 numerical control.



## 1 DESCRIPTION

The Compact 4 is a small device, likely to be installed in electrical cabinet with wall assembly.

The Compact4 presents a series of advantages:

- small size
- reduced consumption

The philosophy of the Compact4 is to bring to the field any peripheral connections through a set of buses.

## 2 FUNCTIONAL SPECIFICATIONS

### 2.1 General features

The features of the device are the following:

- Based on a PC embedded architecture, small in size.
- Wall assembly.
- Connection to a supervisor PC via Ethernet 10/100/1000 Mb/s or, alternatively, possibility of assembly with a touch display and user interface.
- Windows CE operating system.
- External power supply 12 Volts.
- Possibility to manage up to 4 frequency/direction axes in real time at 1ms.
  - Incremental encoder management and zero mark.
  - Fast-in management.
- Management of 32 "PNP" (High Side drive) input/output lines with status indication.
  - 4 sample anti-bounce digital filter.
  - Deactivation of the outputs in short circuit (after 4 samples).
  - Automatic reset of the output in short circuit (after removal of the short circuit - within 1 sec)
  - Galvanic isolation of inputs/outputs.
- Power supply from nominal field of + 24Vdc for the outputs activation.
- Management of a flyer interface with 8 input lines and 8 output lines (5 volts).
- The device is fanless.

### 2.2 Specifications of the control

- Based on 3.5" MPU card with 615MHz (or higher) processor.
- RAM DDR3 1066MHz, 1GBytes (or higher).
- Flash: 512MBytes (or higher).
- Fanless board.
- No.1 CRT output for monitor.
- No.1 PS/2 I/F for mouse + keyboard.
- No.1 serial RS232.
- No.1 serial RS485/RS422 (configurable).



- No. 1 Ethernet LAN for a supervisor PC connection
- No. 1 Ethernet LAN for EtherCAT bus.
- No. 2 USB Ports.

### **2.3 Supported field buses**

- GreenBus v4.0
- CAN Bus (CAN TPA, S-CAN)
- EtherCAT (in Real-time at 4 ms)

### **2.4 Additional functions**

- Feed rate override port.

### **2.5 Power supply specifications**

- Input power supply +12V +/- 10%, 3A
- Protected and filtered input.

### 3 TECHNICAL SPECIFICATIONS

#### 3.1 Device

Processor	615MHz (or higher), 512KB cache
RAM memory	DDR3 1066 MHz, 1GBytes (or higher).
Flash memory	512MB (or higher)
Operating system	Windows CE
Size	200 x 126 mm maximum, h = 65 mm maximum (fixing excluded)
Weight	900 g maximum
Assembly	Wall

#### 3.2 Interfaces

I/O Module	1 serial RS232 1 serial RS485 half-duplex (or RS422 full-duplex) 1 PS/2 for keyboard and mouse
Ethernet	1 Ethernet LAN 10/100/1000 Mb/s
CRT	1 monitor video out
USB	2 USB 2.0
Field bus	CANBUS Management: it can be configured on request GreenBus 4.0 bus 1 LAN dedicated to the EtherCAT bus Interface 4 frequency/direction axes 5 Volts and relative encoder interface 32 I/O High side drives +24Vdc Flyer interface 5 Volts and related I/O signals Possibility of Feed rate

It is possible to use any combination of field bus with exceptions, constraints or limitations that depend on the application.

## 4 ELECTRICAL FEATURES

### 4.1 Generics

#### 4.1.1 Maximum allowed values

Parameter	Condition	Min	Type	Maximum	Unit
Power supply	I <sub>max</sub> = 3A	10.8		13.2	V
Temperature		0		50	°C
Relative humidity	w/o condensation	10		95	%

#### 4.1.2 Operating parameters

Parameter	Condition	Min	Type	Maximum	Unit
Power supply	I <sub>max</sub> = 3A		12.4		V
Temperature		5		45	°C

## 4.2 PNP I/O

### 4.2.1 Maximum allowed values

Parameter	Condition	Min	Type	Maximum	Unit
VO Output Power Supply		16		36	V
On Output Current maximum	VO = 24 Volts DC			1	A
ICC, Power Supply current maximum	VO = 24 Volts DC			16	A

### 4.2.2 Operating parameters

Parameter	Condition	Min	Type	Maximum	Unit
VO Output Power Supply		18	24	30	V
On Output Current	VO = 24V	0		0.5	A
Voh, output high state voltage	VO = 24V, RI = 10KOhm, CI = 50pF	18			V
Vol, output low state voltage	VO = 24V, RI = 10KOhm, CI = 50pF			6	V
Vih, input high state voltage	VO = 24V	18			V
Vil, input low state voltage	VO = 24V			10	V
Logic to output isolation	1-minute duration		500		Vac
	100 ms duration		1100		Vac
Input to logic isolation	1-minute duration		2500		Vac

### 4.3 Frequency/direction axes

#### 4.3.1 Maximum allowed values

Parameter	Condition	Min	Type	Maximum	Unit
Maximum frequency/direction differential output current	(*)			20	mA
Maximum encoder input current				30	mA

(\*) Limited from technology. Not tested.

#### 4.3.2 Operating parameters

Parameter	Condition	Min	Type	Maximum	Unit
Frequency output maximum frequency				1000	kHz
Frequency/direction differential output high state voltage	$I_o = 20 \text{ mA}$	2.4	3.4		V
Frequency/direction differential output low state voltage	$I_o = 20 \text{ mA}$		0.2	0.4	V
Frequency/direction differential common mode output voltage				3	V
encoder differential input high threshold voltage	$T = 25^\circ\text{C}$ , $I_{in} = 5 \text{ mA}$		1.9		V
encoder differential input low threshold voltage	$T = 25^\circ\text{C}$			1.1	V
Incremental encoder frequency				4000	kHz
Input to logic isolation	1-minute duration		2500		Vac

## 4.4 I/f flyer

### 4.4.1 Maximum allowed values

Parameter	Condition	Min	Type	Maximum	Unit
Power supply current	provided			250	mA
Output current				20	mA
Input current				20	mA
Encoder input current				45	mA
On input voltage				6.5	V

### 4.4.2 Operating parameters

Parameter	Condition	Min	Type	Maximum	Unit
Power supply	provided, $I = 160\text{mA}$		5		V
Voh, output high state voltage	$I = 5\text{mA}$ , $V_{cc} = 5\text{V}$	4			V
Vol, output low state voltage	$I = 5\text{mA}$ , $V_{cc} = 5\text{V}$			0.4	V
Vih, input high state voltage	$V_{cc} = 5\text{V}$	2			V
Vil, input low state voltage	$V_{cc} = 5\text{V}$			0.8	V
encoder differential input high threshold voltage	$T = 25^\circ\text{C}$ , $I_{in} = 5\text{mA}$		1.6		V
encoder differential input low threshold voltage	$T = 25^\circ\text{C}$			1.1	V
Incremental encoder frequency				4000	kHz

### 5 SIZE AND FIXING

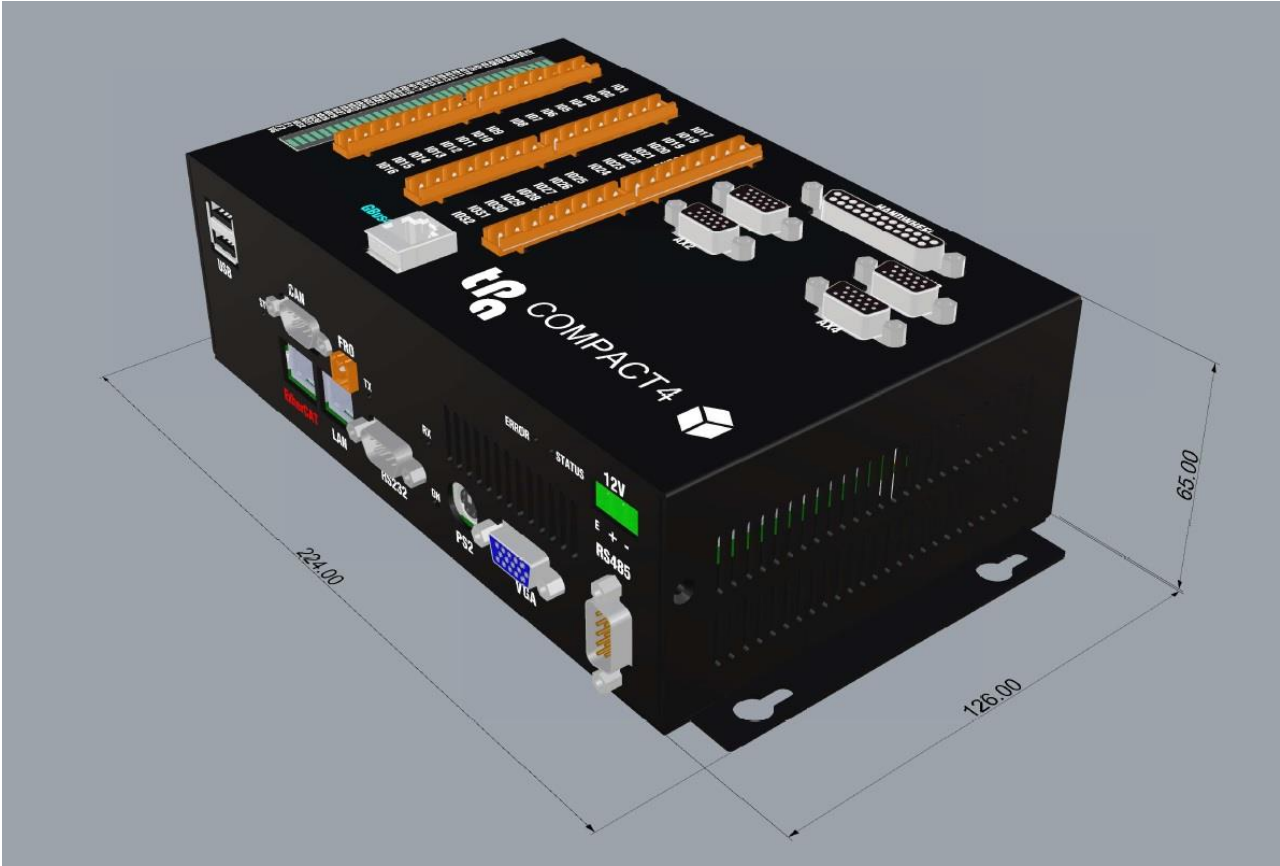

## 6 INTERFACES DESCRIPTIONS

### 6.1 Power supply connector

# 12V

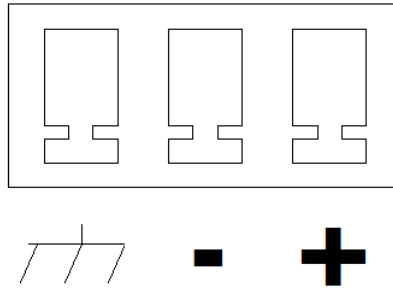

### 6.2 PS/2 connector for Keyboard and Mouse

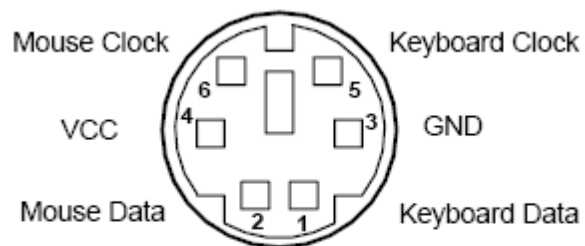



### 6.3 RS232 and RS485 connectors

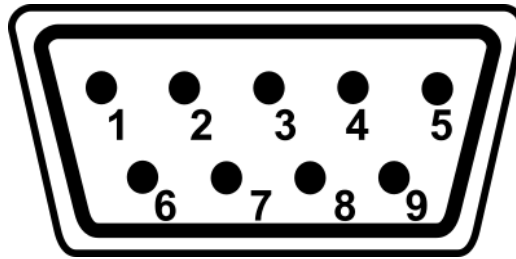

Pin	RS232
1	DCD
2	RX
3	TX
4	DTR
5	GND
6	DSR
7	RTS
8	CTS
9	RING

Pin	RS485	RS422 (on request)
1	DATA-	TX-
2	DATA+	TX+
3	nc	RX+
4	nc	RX-
5	GND	GND
6	nc	nc
7	nc	nc
8	nc	nc
9	nc	nc

## 6.4 VGA video out connector

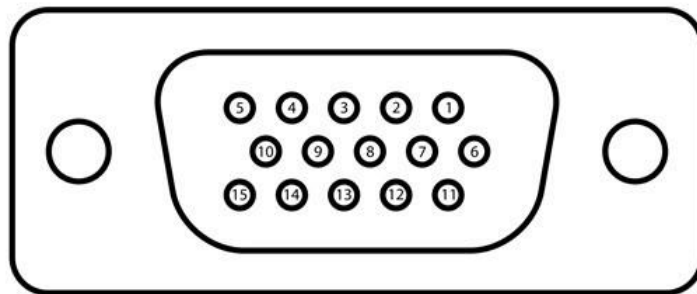

Pin	Description
1	Red
2	Green
3	Blue
4	nc
5	Gnd
6	AGnd
7	AGnd
8	AGnd
9	nc
10	Gnd
11	nc
12	DDC dat
13	HSync
14	VSynC
15	DDC Clk

## 6.5 LAN and EtherCAT connectors

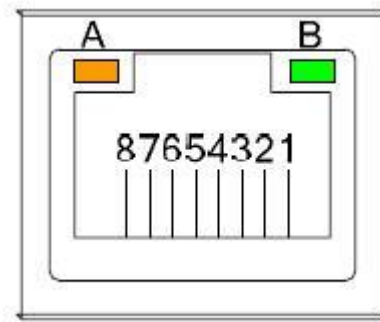

Pin	Description
1	MDI0+
2	MDI0-
3	MDI1+
4	MDI2+
5	MDI2-
6	MDI1-
7	MDI3+
8	MDI3-
A	Act Link LED
B	Speed LED

## 6.6 USB connectors

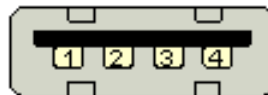

Pin	Description
1	USB Vcc
2	USB -
3	USB +
4	USB Gnd

## 6.7 I/f flyer connector

See chapter 8.

## 6.8 Frequency/direction axes connectors

See chapter 8.

## 6.9 I/O terminal blocks

See chapter 8.

## 6.10 I/O power supply terminal blocks

For the I/O power supply, 2 terminal blocks with 8 poles (AWG24, 12 connection) are made available, one for the power supply tension +24Vdc and one for the related ground wire (GND24). These terminal blocks can be even used as return of the field power towards other wirings.

The presence of a valid power supply is indicated by the yellow LED VG.

**Warning!** To deploy the full power supplied by the Compact4 I/O, it is necessary to wire at least 2 pins for each terminal block.

## 6.11 GBus4 connector

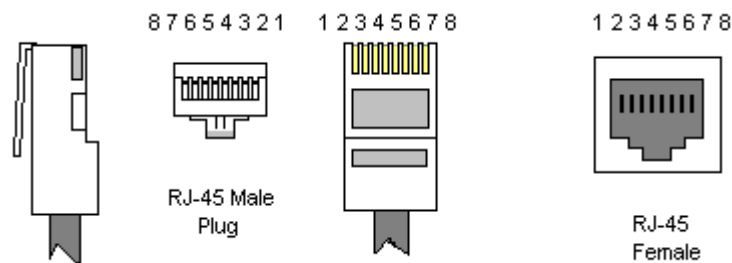

Pin	Name	Function	Notes
1	0 V	Negative GreenBus power supply	
2	+12 V	GreenBus power supply (+12 Volts $\pm$ 5%)	Maximum 0.7A
3	0 V	Negative GreenBus power supply	
4	TX+	GreenBus Tx (positive signal)	120 ohms termination
5	TX-	GreenBus Tx (negative signal)	
6	+12 V	GreenBus power supply (+12 Volts $\pm$ 5%)	Maximum 0.7A
7	RX+	GreenBus Rx (positive signal)	120 ohms termination
8	RX-	GreenBus Rx (negative signal)	
Shield	Ground		

**Warning!** TX and RX are always referred to the transmitter.

The GreenBus v4.0 serial channel requires a device-to-device wiring realised with sections of Ethernet cables complete with RJ45 connector. Given the frequency of data transmission, to prevent the effect of possible electromagnetic interferences, it is recommended the employ of Cat.6 S/STP cables. The S/STP cables have all twisted and individually shielded pairs as well as an overall screen.

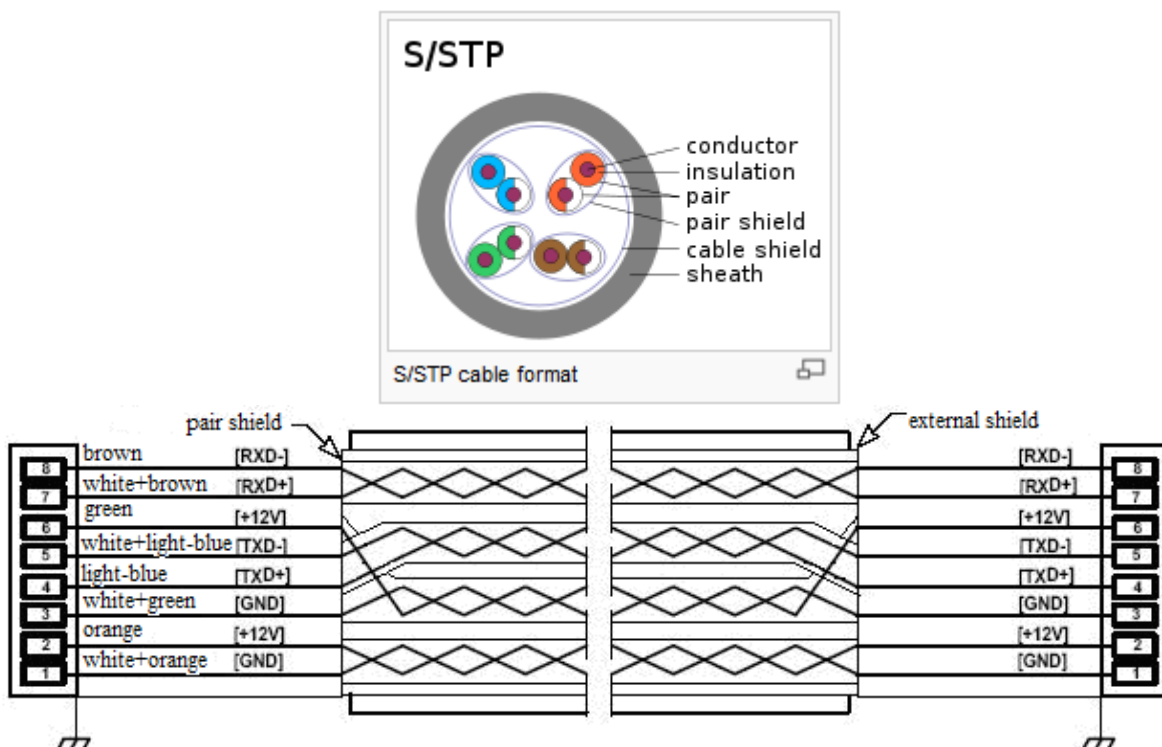

Generally, the wiring must be contained in the lengths.

**Warning!** The Compact4 control **DOES NOT ADMIT** the employ of STAR-TRS remote modules.

Each section of the GreenBus v4.0 channel must be terminated in line with the last physically connected remote device (the most distant); the termination is operated by activating (ON) the 7 and 8 Dip-Switches located on the remote device.

**Warning!** The GreenBus v4.0 channel will not work properly without the termination and the Cnc Albatros will return a series of communication errors. The same will happen if

the termination was also performed on other remote devices located on the same section.

**Warning!** Do not use Ethernet crossover cables (also called "patch cables").

## 6.12 CAN connector

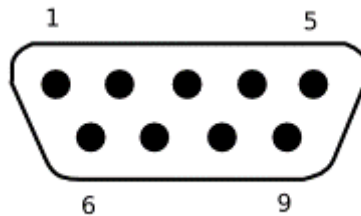

Pin	Name	Function
1	----	
2	CANL	Can Low (Can negative signal)
3	0 Volt	
4	----	
5	Ground	
6	0 Volt	
7	CANH	Can High (Can positive signal)
8	----	
9	CANV+	Can Voltage (power supply presence)
Shield	Ground	

The CAN serial channel needs a wiring with shielded pair ( $Z = 100$  ohms). It is also necessary to provide power supply to remote devices. This power supply (typically +24V) can be brought back to the control input of the CANV+ power supply.

The signal cable must be conveniently terminated on the last receiver with a fireproof wire-wound resistor of 100 - 120 ohms (0,5 Watts).

**Warning!** The CAN channel may not work correctly without the termination, or it could have more susceptibility to interferences. The same will happen if the termination is also performed on other remote devices located on the same section.

Figure and table below show the prescriptions of the bus wiring and length.

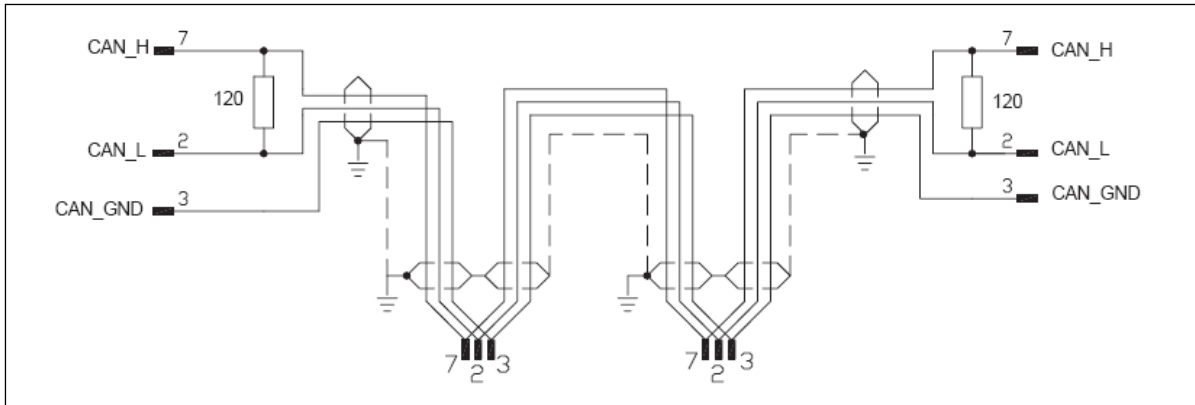

Baud rate (Kb/s)	Maximum bus length (m)	Wire gauge (Ohm/Km)	Loop resistance (mm2)
125	500	40	0.50 – 0.60
250	250	60	0.34 – 0.60
500	100	60	0.34 – 0.60
1000	40	70	0.25 – 0.34

### 6.13 FRO connector

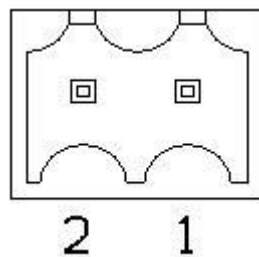

Pin	Name	Function	Notes
1 – right	FRO+	Feed-Rate input	Empty +3.6 Volts. Connect 5Kohms (4K7) potentiometer. At load, range 0 ÷ 3.3 Volts
2 – left	0 Volt	Negative power supply	

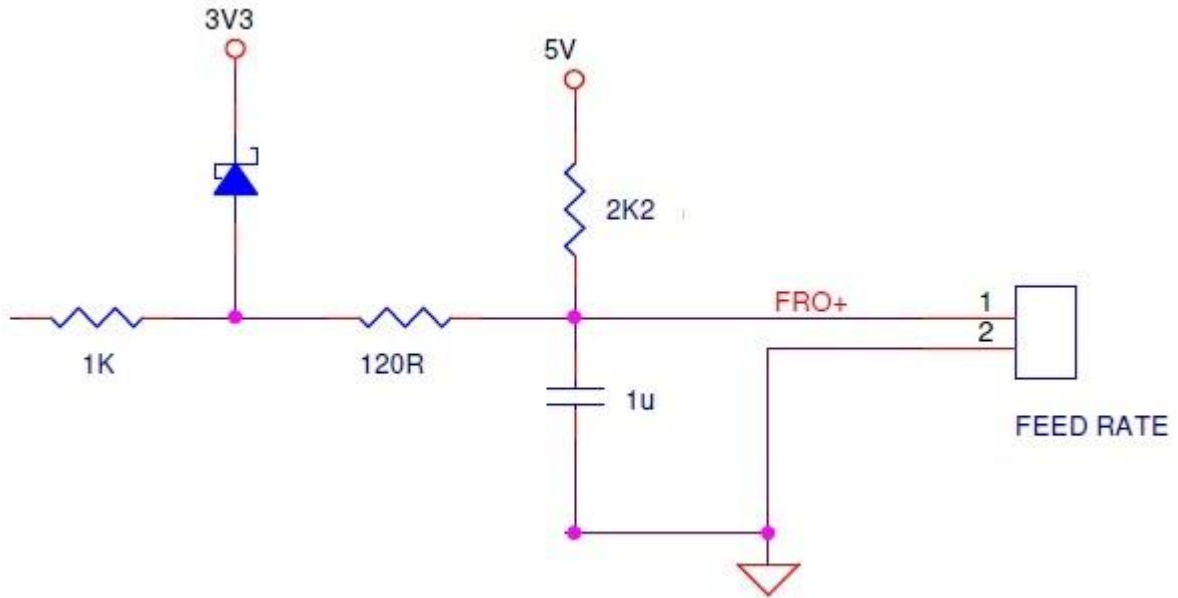

For the Feed-Rate potentiometer connection it must be used a shielded lead. The screen must be connected to the ground. If the potentiometer has a metal box: make sure that the box is earthed.

For the potentiometer connection, refer to the following diagram.

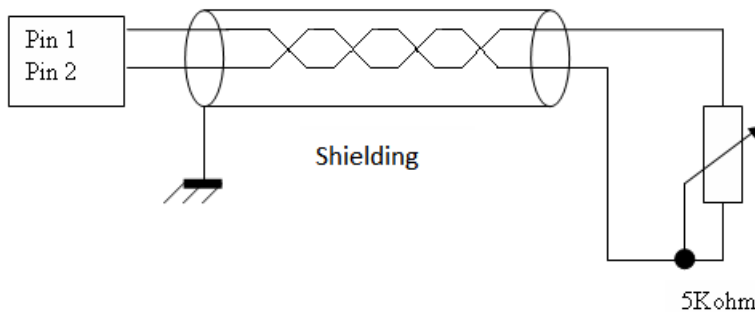

## 6.14 Bright signals

### 6.14.1 LED ON

The LED located next to the RS232 connector indicates the control operating status. It is normally switched on a green-red two-colour.



### 6.14.2 Red LED (ERR)

It reports the system error status.

- In case of error it stays ON until the problem is removed, followed by other indications given by other LEDs (loss of a power supply, disconnection from GreenBus, etc.).
- In case of serious HW fault it stays ON and the STA LED results off (dead-lock condition).

### 6.14.3 Green LED (STA)

It is normally ON flashing with a frequency of approximately one second.

It completely remains OFF and accompanied by the ERR LED ON in case of a serious HW fault (dead-lock condition).

### 6.14.4 ST LED

It reports the CAN bus status.

Modality	Meaning
Flashing of the CAN bus LED (regular on-off for about 1 sec)	CAN condition not yet initialized
Flashing of the CAN bus LED (regular very fast on-off)	Condition of initialized CAN bus channel, regular operation
Impulsive flashing of the CAN bus LED (impulsive off-on-off, 1 sec)	Initialized card, except no selected field bus
CAN LED OFF	The CAN bus is not active, and an error has occurred

### 6.14.5 GreenBus LED

They report the GreenBus 4.0 bus status.

Modality	Meaning
Irregular flashing of both LEDs	Condition of initialized GreenBus channel, regular operation
Regular flashing of the only transmission LED (Yellow)	A disconnection of at least one remote module has occurred, so the transmission works, but not the reception
Common flashing of the GreenBus LEDs (regular on-off for about 1 sec)	GreenBus not yet initialized
Impulsive flashing of the GreenBus LEDs (impulsive off-on-off, 1 sec)	Initialized card, except no selected field bus

### 6.14.6 I/O yellow LED

It reports the corresponding I/O status.

- It is ON when the logic status is 1
- It is OFF when the logic status is 0

### 6.14.7 VG yellow LED

It reports the +24Vdc power supply presence

- It is ON when the power supply is present.
- It is OFF when the power supply is absent or out of the range of admissibility.

### 6.14.8 FX yellow LED

When ON, they report serious functional errors. They must always remain OFF during the normal operation

## 7 PRESCRIPTIONS

Generally, it is mandatory not to exceed the values of power supply, temperature and humidity indicated in chapter 4.

It is mandatory to interconnect the Compact4 through cables/terminals and everything else as indicated in chapters 5 and 7.

It is mandatory to connect (via power connector) the Compact4 to the ground.

It is recommended the Compact4 installation in electrical cabinet/panel.

The Compact4 is a computerized numerical control for the general use in a light industrial environment.

It is a class A product and if it is installed in a domestic environment, it can cause electromagnetic interferences, so the end user must take all the necessary precautions.

### 7.1 Operating temperature

The environmental operating temperature ranges from 5°C to 45°C.

### 7.2 Power supply

For the use of the Compact4 it is recommended the power supply (AC/DC converter) Mean-Well MDR40-12.

However, it can be used a power supply (AC/DC converter) that has the following characteristics:  $V_{out} = 12V \text{ dc. } \pm 10\%$ ,  $I_{out} = 3A$ .

## 8 FIELD CONNECTIONS

### 8.1 Axes connectors

The connector box is integral with the Compact4 box, with the DIN guide anchoring block (metallic ground wire) and with the ground pin. The figure shows the wiring with the TPA "type B-axis cable".

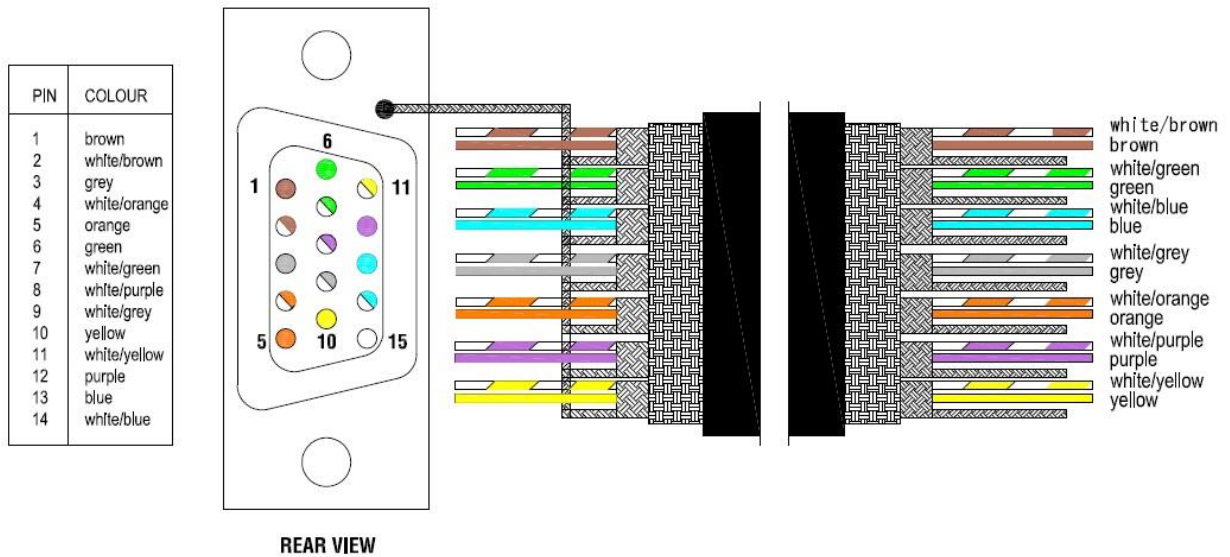

1	A PHASE		brown
2	A\ PHASE		white/brown
3	FINP+		grey
4	0V		white/orange
5			
6	B PHASE		green
7	B\ PHASE		white/green
8	FREQ\		white/purple
9	FINP-		white/grey
10	SIGN		yellow
11	SIGN\		white/yellow
12	FREQ		purple
13	C PHASE		blue
14	C\ PHASE		white/blue
15			

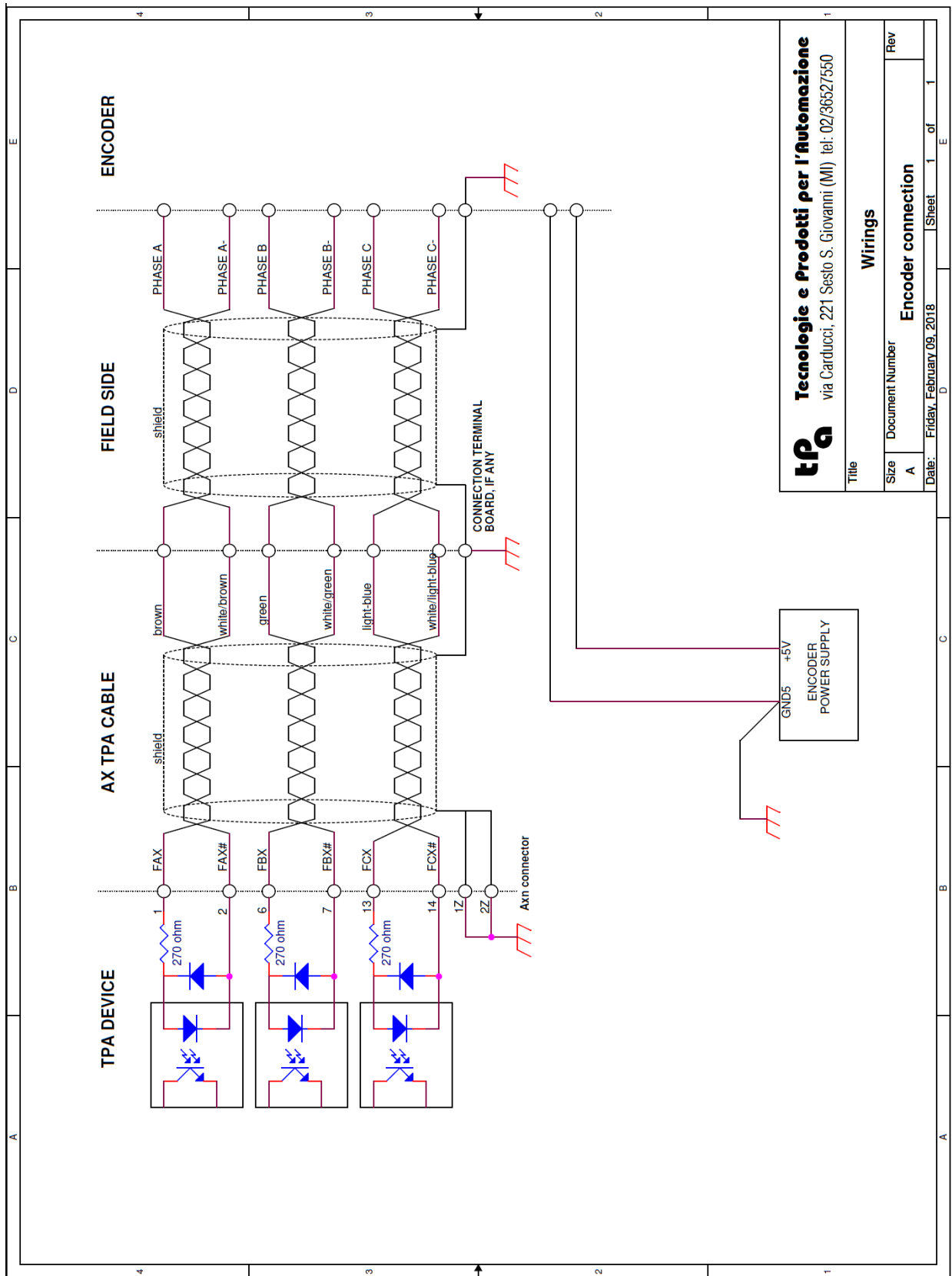

**TPA** **Tecnologie e Prodotti per l'Automazione**  
 via Carducci, 221 Sesto S. Giovanni (MI) tel: 02/36527550

Title: **Wirings**

Size	Document Number	Rev
A	<b>Encoder connection</b>	

Date: Friday, February 09, 2018 Sheet 1 of 1

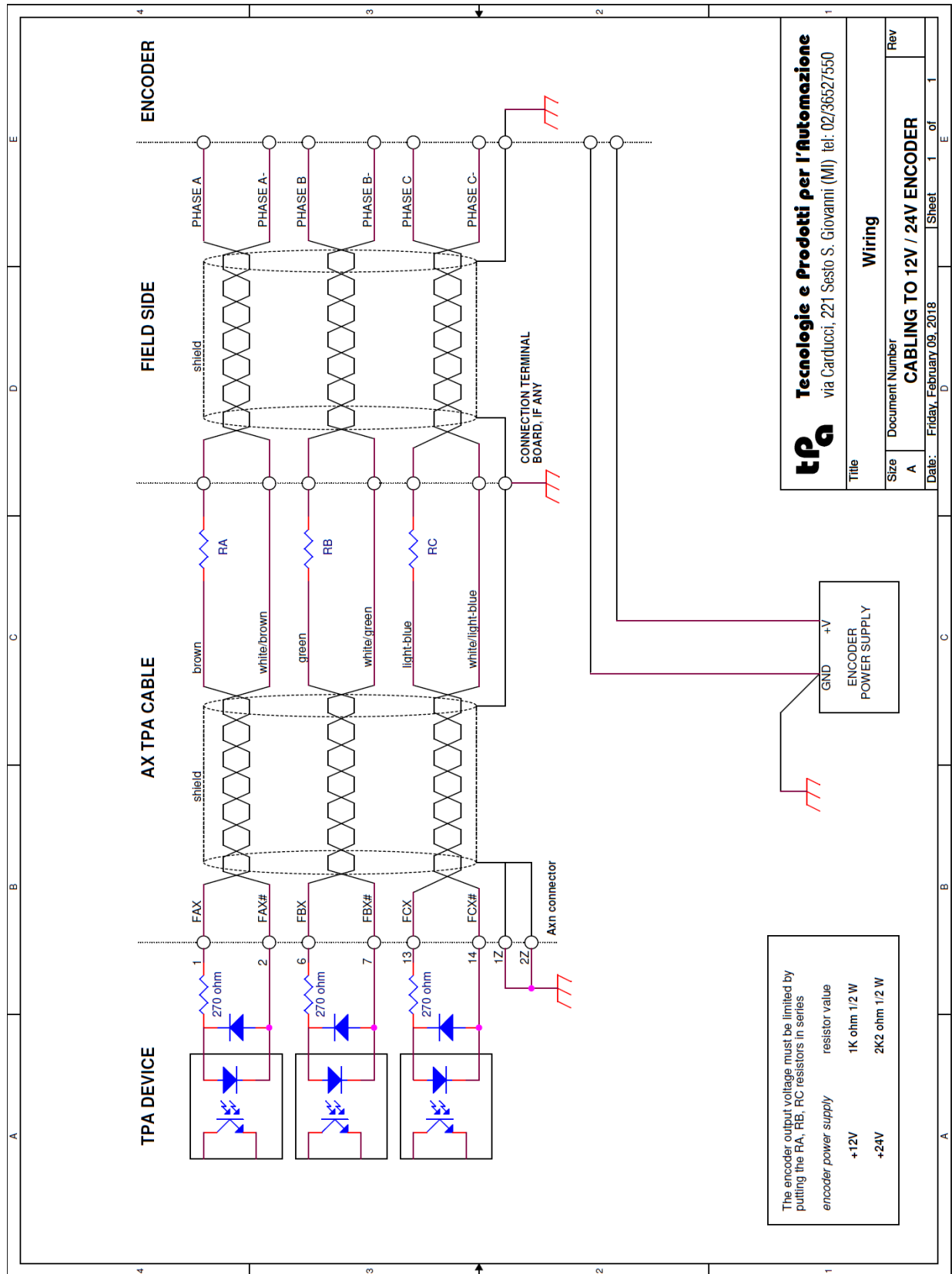

**TPA** **Tecnologie e Prodotti per l'Automazione**  
 via Carducci, 221 Sesto S. Giovanni (MI) tel: 02/36527550

Title: **Wiring**

Document Number: **CABLING TO 12V / 24V ENCODER**

Size: A

Date: Friday, February 09, 2018

Sheet: 1 of 1

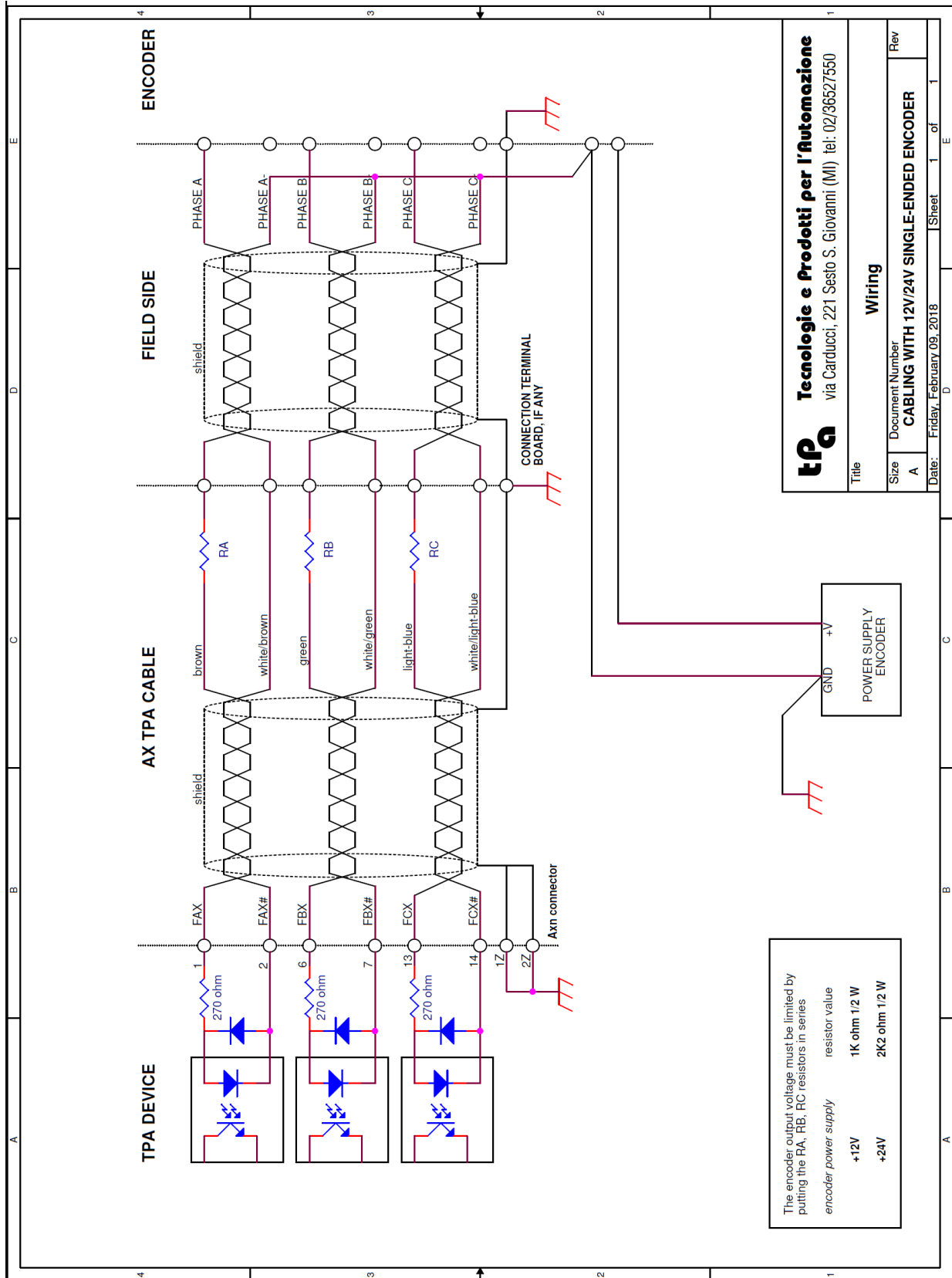

**TPA** **Tecnologie e Prodotti per l'Automazione**  
 via Carducci, 221 Sesto S. Giovanni (MI) tel: 02/36527550

Title: **Wiring**

Document Number: **CABLING WITH 12V/24V SINGLE-ENDED ENCODER**

Size: A

Date: Friday, February 09, 2018

Sheet: 1 of 1

Rev

**Warning:** in some cases, it may be necessary to balance the A, B, C channels by using 2 resistors of same value (half RA, RB, RC) to be placed on both the positive (FAX, FBX, FCX) and negative (FAX#, FBX#, FCX#) branch.

## 8.2 Flyer connector

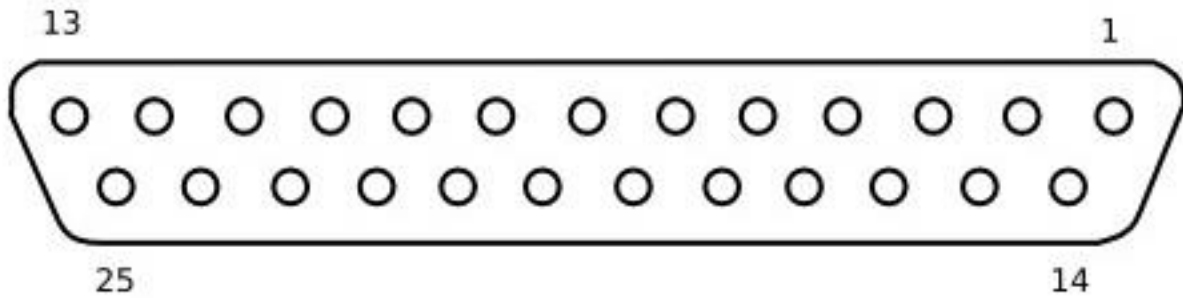

1	A PHASE		
2	A\ PHASE		
3	OV1		
4	OV2		
5	OV3		
6	B PHASE		
7	B\ PHASE		
8	OV4		
9	OV5		
10	OV6		
11	OV7		
12	OV8		
13	0V (GND OUT)		
14	+5V (COM IN)		
15	0V (GND IN)		
16	INV9		
17	INV10		
18	INV11		
19	+5V		
20	0V		
21	INV12		
22	INV13		
23	INV14		
24	INV15		
25	INV16		

### 8.2.1 Flyer wiring example

The following figure shows, as an example, the wiring of a HCN 5V differential flyer type HNC-B-021 on a DB25 male connector.



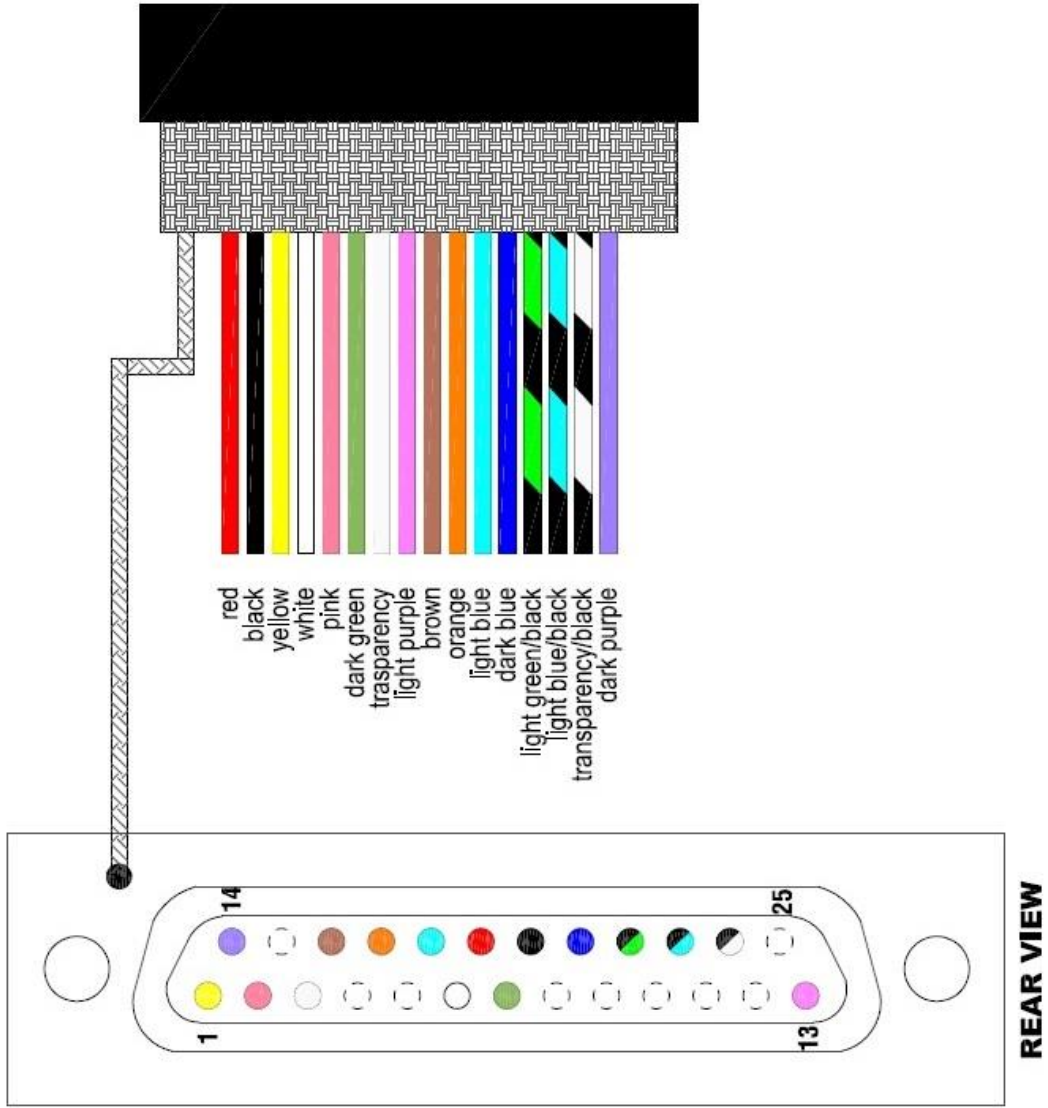

PIN	SIGNAL	COLOR	NOTE
1	A	Yellow	PHASE A
2	/A	Pink	PHASE A\
3	+L	Transparency	OV1
4	n.c.		
5	n.c.		
6	B	White	PHASE B
7	/B	Dark green	PHASE B\
8	n.c.		
9	n.c.		
10	n.c.		
11	n.c.		
12	n.c.		
13	-L	Light purple	0V (GND OUT)
14	COM	Dark purple	+5V (COM IN)
15	n.c.		
16	X	Brown	INV9
17	Y	Orange	INV10
18	Z	Light blue	INV11
19	+5V	Red	+5V
20	0V	Black	0V
21	4	Dark blue	INV12
22	X1	Light green/black	INV13
23	X10	Light blue/black	INV14
24	X100	Transparency/black	INV15
25	n.c.		

### 8.3 I/O terminal blocks

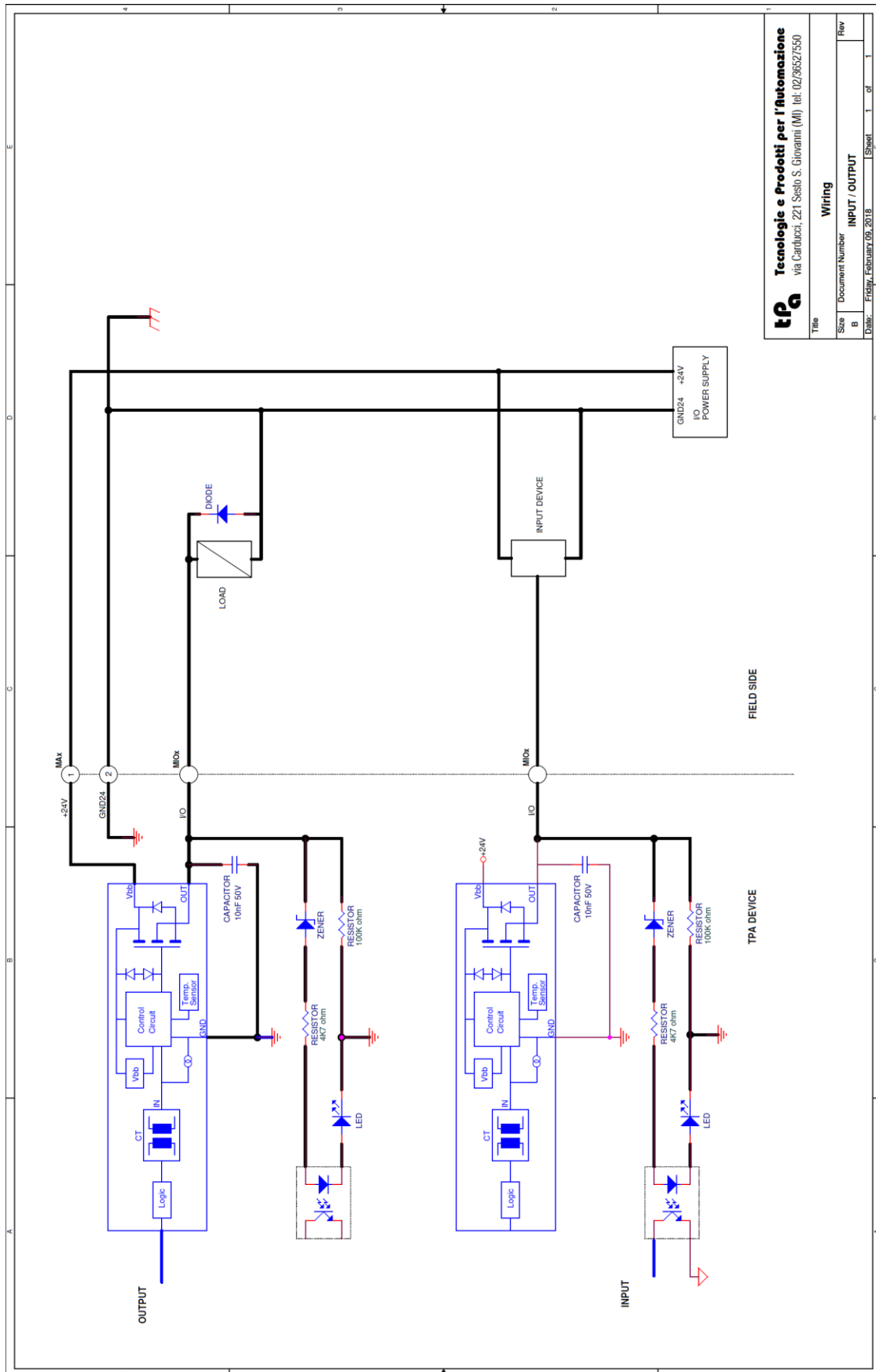

### 8.4 Supervisor PC

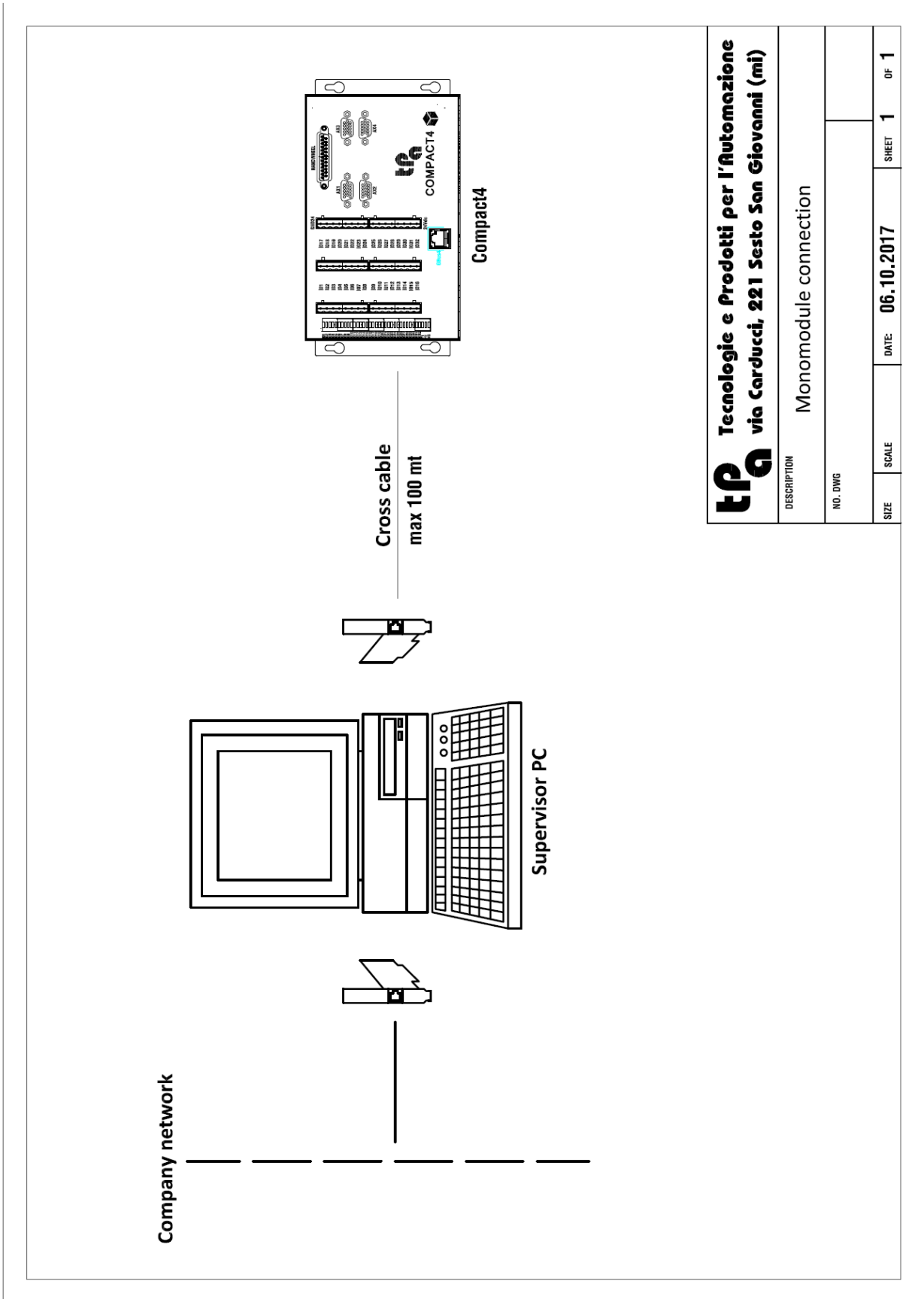

<b>tfa</b> Tecnologie e Prodotti per l'Automazione via Carducci, 221 Sesto San Giovanni (mi)			
DESCRIPTION			
Monomodule connection			
NO. DWG			
SIZE	SCALE	DATE	SHEET
		06.10.2017	1 OF 1

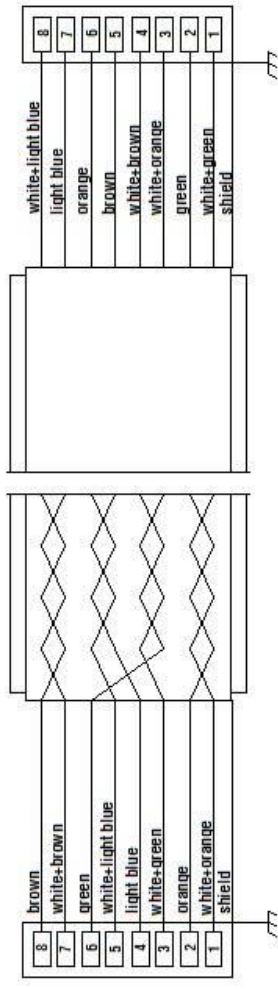

on RJ45 connector colours sequence is in conformity with the T568B legislation

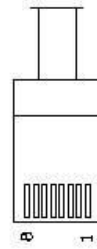

RJ45 connector with green cap

PATCH cable SFTP cat. 5E - flexible and shielded  
 based on IEEE802.3 and 802.3U charts  
 tested at 100 Mbps  
 4 x 2 x AWG26

<b>Tecnologie e Prodotti per l'Automazione</b> via Carducci, 221 Sesto San Giovanni (mi)			
DESCRIPTION	Cross Network Cable		
NO. 016			
SIZE	B	SCALE	1:1
DATE		SHEET	01



**T.P.A. Srl Tecnologie e Prodotti per l'Automazione**

Via Carducci, 221 - 20099 Sesto S. Giovanni  
Tel. +390236527550 - fax: +39022481008  
email: [marketing@tpaspa.it](mailto:marketing@tpaspa.it) - [www.tpaspa.it](http://www.tpaspa.it)  
VAT: IT02016240968 Fiscal code: 06658040156

