



TRS67-8I-80

Bus Coupler EtherCAT IP67

Documentation

Note

This instruction is used for TRS67-8I-8O Remote IO module.

This instruction is about the specifications, installation, main function and the configuration process of TRS67-8I-8O IP67 Remote IO module.

Application

This instruction application to the following:

- Electrical engineer
- Field installation workers.

Disclaimer

This manual is based on existing information, and its contents are subject to change without notice. Tpa has done its best to ensure that its content is accurate and reliable when writing this manual but shall not be liable for the loss and damage caused by omission, inaccuracy, or typographical errors in this manual.

Product information

The TRS67-8I-8O series remote IO module is a 16-channel industrial digital input and output module independently developed by Tpa that complies with the EtherCAT V5.1 communication protocol. This series of products uses M12 T Code coded connectors for power supply. Compared with the traditional 7/8" connector, not only it can provide a larger current (12 A), but also save valuable on-site installation space. All channel ports of the TRS67-8I-8O support fault diagnosis alarms and short-circuit self-recovery functions, which can help engineers quickly locate and find on-site faults and reduce maintenance costs.

Dimensions

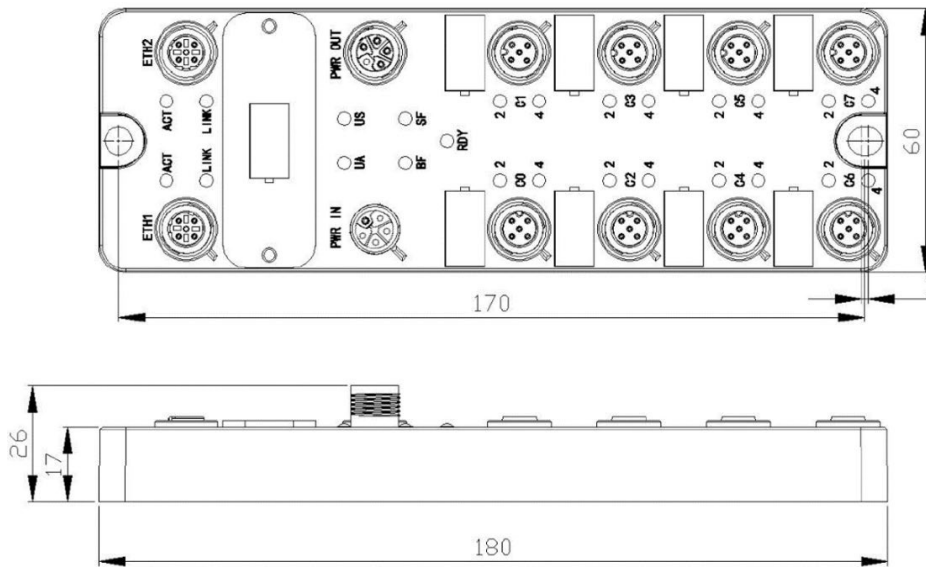

ITEM	INPUT	OUTPUT
TRS67-8I-8O	C0-C3	C4-C7

Description of each port

1.3.1 Signal and power

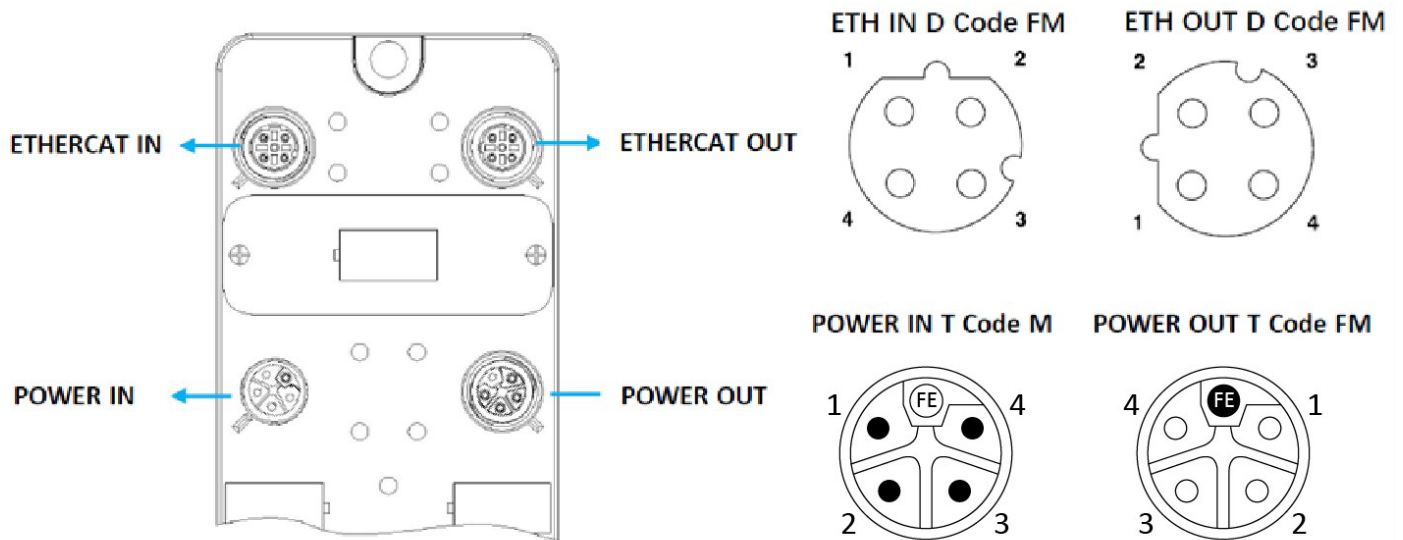

Contact definition

Contact No.	ETH (ETHERCAT)	PWR (POWER)
1	TX+	24V (US+)
2	RX+	GND (UA-)
3	TX-	GND (US-)
4	RX-	24V (UA+)

1.3.2 I/O signal

A code F

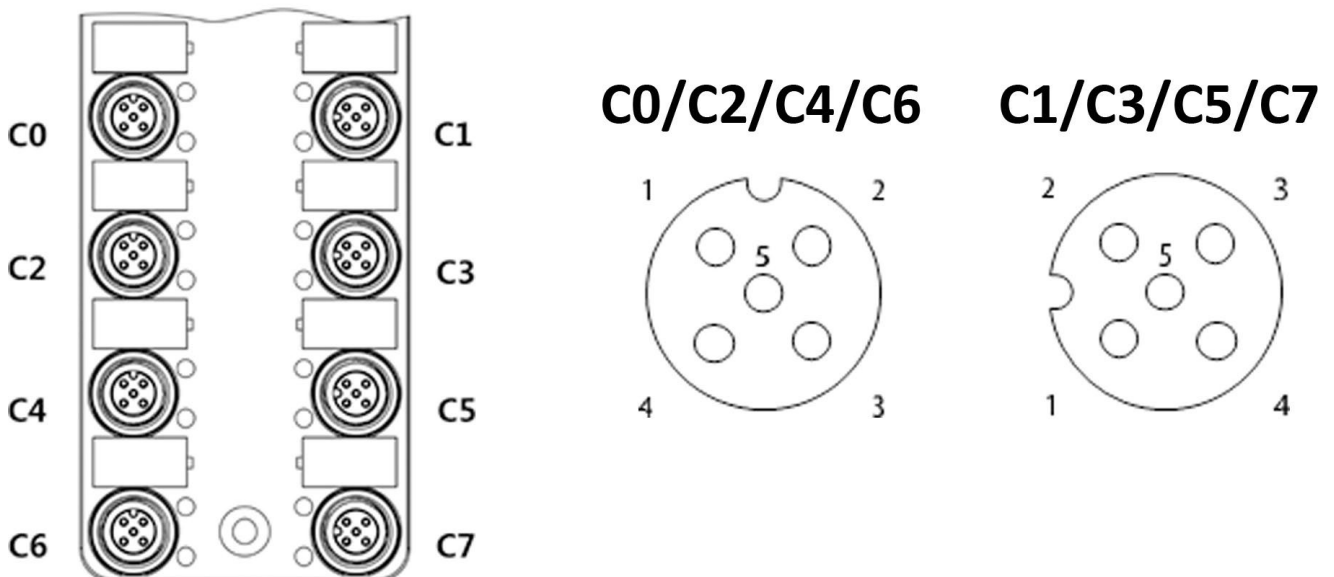

Contact definition

PIN	Description
1	24 V
2	PIN 2 signal
3	GND
4	PIN 4 signal
5	FE

Description of the lights

Light indicator of EtherCAT and Power

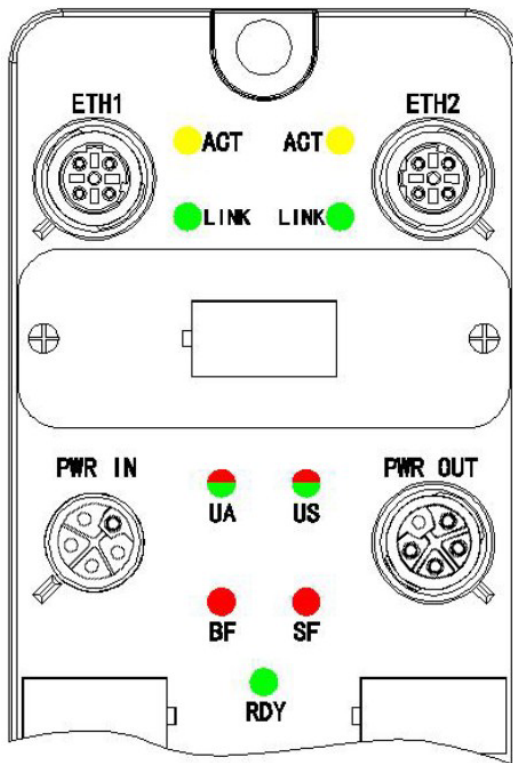

Indicator light	Color	Definition	State	Description
LINK	GN	Connection	green	ETH 1/2 connected
			extinguish	ETH 1/2 unconnected
ACT	YE	Acting	flash	ETH 1/2 data transmission
			extinguish	ETH 1/2 without data transmission
RDY	GN	Ready	green	Device turned on, will also remain after the normal communication of the device is disconnected
			flash	Waiting for CPU synchronization
			extinguish	Device did not turn on
BF	RD	Break	red	Unconnected with EtherCAT control
			extinguish	Connection with EtherCAT control
SF	RD	Inspection error	red	Inspection error exists
			extinguish	None

US	GN/RD	Sensor power	green	US power supply normal
			extinguish	US power supply out
			red	US power supply undervoltage (under 18 V)
UA	GN/RD	Device power	green	UA power supply normal
			extinguish	UA power supply out
			red	UA power supply undervoltage (under 18 V)

Light indicator of I/O signal

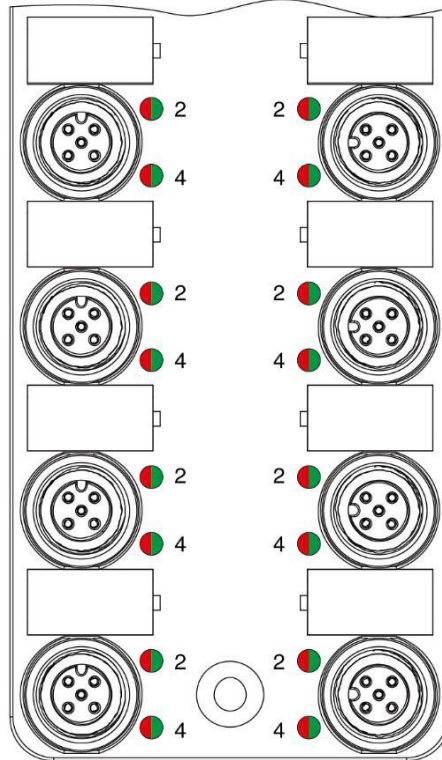

Light	Color	Define	State	Description
2	GN/RD	Signal performance of PIN 2	green	Signal exists in Pin2
			extinguish	No signal exists in Pin2
			red	Pin2 output overload short circuit
2 @ 4 red at the same time				Pin1(power) overload short circuit
4	GN/RN	Signal performance of PIN 2	green	Signal exists in Pin4
			extinguish	No signal exists in Pin4
			red	Pin2 output overload short circuit

2.1 Connectors and Accessories

	M12 connector - I/O TRS8.3.04
	M12 connector – Power in Metal TRS8.3.03
	M12 connector – Power out Metal TRS8.3.11
	M12 connector – EtherCAT TRS8.3.01
	M12 connector male to 2M8 female – I/O TRS8.3.05
	M12 cover for female

2.2 Connect description

2.2.1 Device grounding

To avoid data damage or loss, please ensure that the device is well grounded.

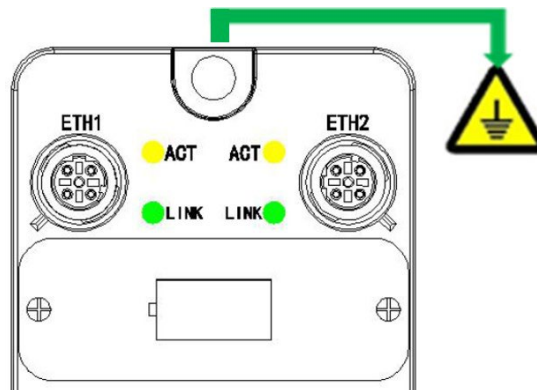

2.2.2 Shielded Cable

To avoid data damage or loss, use the EtherCAT cable, ensure that the shielding layer of the cable is well grounded.

2.2.3 Power supply

TRS67-8I-8O module power supply use M12 Tcode connection.

Module system and DI supported with US power supply, DO with UA power supply. Power range 18-30 VDC, current 12 A. If the module uses series power supply, please pay attention to the voltage drop and the total current of the power supply.

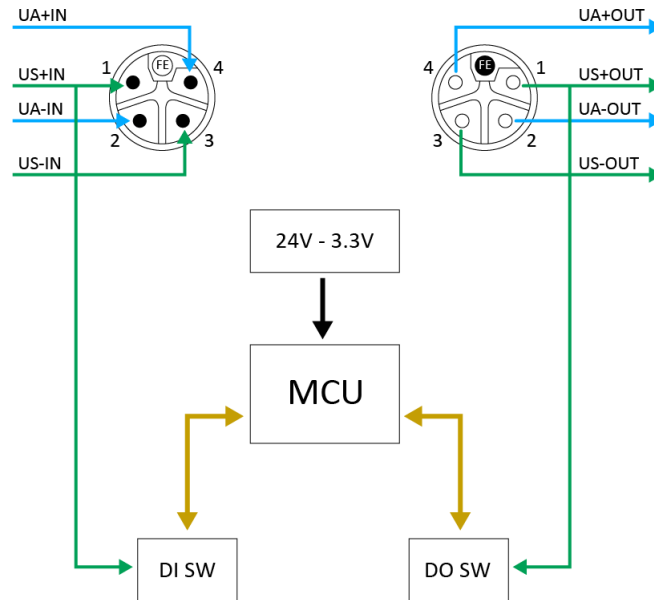

Typical connection diagram

2.2.4 IO connection

TRS67-8I-8O series IO signal is PNP. Please pay attention to the wiring method when connecting the sensor and actuator, the typical connection diagram is shown below.

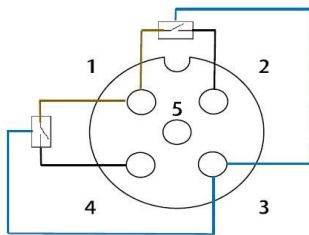

Typical Connection diagram input

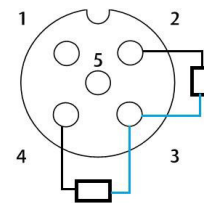

Typical Connection diagram output

2.3 Device fasten

Please use standard M4 screws to fix the module, the fixing surface should be kept flat, the module cannot bear bending stress.

Chapter three: Configuration and operation instructions

3.1 ESI file

TRS67-8I-8O use equipment description files (ESI) that comply with the EtherCAT V2.3 standard

3.2 Main parameters

Housing material	PC
Filler material	Polyurethane
Metal material	Copper nickel plated
Weight	300 g
Operating temperature	-25 – 60 °C If the device is used at an ambient temperature higher than 50 °C, be careful of high temperature burns when it contacts with the metal surface of the device
Storage temperature	From -30 to 70 °C
Operating humidity	From 5% to 95%
Storage humidity	From 5% to 95%
Operating pressure	From 70 to 106 kPa
Protecting degree	IP67

3.3 EtherCAT

Port	2
Transmission	Copper cable
Connect method	M12 D code 4 pin
Transmission speed	100 Mbps
Device type	EtherCAT Device
Consistency	Class B
Refresh time	2 ms
EtherCAT protocol	COE FOE

3.4 US device and sensor power supply

Connection method	M12 T code 4 pin
Input voltage	18-30 VDC
Output current	Max. 12 A
Reverse polarity protection	Yes
Current consumption	120 mA/no load

3.5 UA actuator power supply

Connection method	M12 T code 4 pin
Input voltage	18-30 VDC
Output current	Max. 12 A
Reverse polarity protection	Yes
Current consumption	5 mA/no load

3.6 IO connection

Connection method	M12 A code 5 pin
Type	PNP
Input type	EN 61131-2 types 1 and 3
IO typical voltage	24 VDC
Actuator current	500 mA/one signal
Sensor current	500 mA/one signal
Protection of overload and short circuit	870 mA/self-fixable

3.7 Electrical isolation

Testing parts	Testing voltage
US power supply/ETH 1	500 V AC, 50 Hz, 1 Min
US power supply/ETH 2	500 V AC, 50 Hz, 1 Min
US power supply/FE	500 V AC, 50 Hz, 1 Min
ETH 1/FE	500 V AC, 50 Hz, 1 Min
ETH 2/FE	500 V AC, 50 Hz, 1 Min

ETH 1/ETH 2	500 V AC, 50 Hz, 1 Min
US/UA power supply	500 V AC, 50 Hz, 1 Min
UA power supply/ETH 1	500 V AC, 50 Hz, 1 Min
UA power supply/ETH 2	500 V AC, 50 Hz, 1 Min
UA power supply/FE	500 V AC, 50 Hz, 1 Min

3.8 Mechanical test

Vibration resistance according to EN60068-2-6/IEC60068-2-6	5 g
Shock complies with EN 60068-2-27/IEC 60068-2-27	30 g, 1 ms cycle, half-sine shock pulse
Continuous impact according to EN60068-2-27/IEC60068-2-27	10 g

3.9 EMC test

Noise immunity test complies with EN 61000-6-2 standard	
ESD EN 61000-4-2/IEC 61000-4-2	Standard B, 6 kV contact discharge, 8 kV air discharge
Electromagnetic field EN 61000-4-3/IEC 61000-4-3	Standard A, field strength: 10 V/m
Electrical fast transient burst immunity EN 61000-4-4/IEC 61000-4-4	Standard B, 2 kV
Surge immunity (Surge) EN 61000-4-5/IEC 61000-4-5	Standard B; DC power cord: ± 0.5 kV/ ± 0.5 kV (symmetry/asymmetry)
Conducted interference EN 61000-4-6/IEC 61000-4-6	Standard A; testing voltage 10 V
Noise emission test according to EN 61000-6-4	
Radio interference EN 55022	Class A



T.P.A. Srl Tecnologie e Prodotti per l'Automazione – Via Carducci, 221 – 20099 Sesto S. Giovanni
 Tel. +390236527550 – www.tpaspa.com – P.I.: IT02016240968